



Installation- and Operating instructions for

CU8801-0000

USB2.0-Extender-Tx

Version: 1.3

Date: 2017-06-13

BECKHOFF

Table of contents

1	Foreword	3
1.1	Notes on the Documentation	3
1.1.1	Liability Conditions	3
1.1.2	Trademarks	3
1.1.3	Patent Pending	3
1.1.4	Copyright	3
1.1.5	State at Delivery	3
1.1.6	Delivery conditions	3
1.2	Description of safety symbols	4
1.3	Operator's obligation to exercise diligence	4
2	Product Description	5
2.1	Product Overview	5
2.2	Connections	6
2.2.1	Power Supply	6
2.2.2	Data Connections	6
2.3	LED-Diagnostics	7
3	Installation	8
3.1	Transport and Unpacking	8
3.1.1	Transport	8
3.1.2	Unpacking	8
3.2	Mounting/ Demounting	9
3.3	Connecting devices	10
3.3.1	Connecting cables	10
3.3.2	Connecting Power Supply	10
4	Operation	11
4.1	Architecture Description	11
4.1.1	Configuration 1	11
4.1.2	Configuration 2	11
4.2	Maintenance	12
4.2.1	Cleaning	12
4.2.2	Maintenance	12
4.3	Shutting down	12
4.3.1	Disposal	12
5	Dimensions	13
6	Technical Data	14
7	Appendix	15

7.1	Beckhoff Support and Service	15
7.1.1	Beckhoff branches and partner companies	15
7.1.2	Beckhoff company headquarters	15
7.2	Approvals for USA and Canada	16
7.3	FCC Approval for USA	16
7.4	FCC Approval for Canada	16

1 Foreword

1.1 Notes on the Documentation

This description is only intended for the use of trained specialists in control and automation engineering who are familiar with the applicable national standards. It is essential that the following notes and explanations are followed when installing and commissioning these components.

The responsible staff must ensure that the application or use of the products described satisfy all the requirements for safety, including all the relevant laws, regulations, guidelines and standards.

1.1.1 Liability Conditions

The documentation has been prepared with care. The products described are, however, constantly under development. For that reason the documentation is not in every case checked for consistency with performance data, standards or other characteristics. In the event that it contains technical or editorial errors, we retain the right to make alterations at any time and without warning. No claims for the modification of products that have already been supplied may be made on the basis of the data, diagrams and descriptions in this documentation.

1.1.2 Trademarks

Beckhoff®, TwinCAT®, EtherCAT®, Safety over EtherCAT®, TwinSAFE® and XFC® are registered trademarks of and licensed by Beckhoff Automation GmbH.

Other designations used in this publication may be trademarks whose use by third parties for their own purposes could violate the rights of the owners.

1.1.3 Patent Pending

The EtherCAT Technology is covered, including but not limited to the following patent applications and patents: EP1590927, EP1789857, DE102004044764, DE102007017835 with corresponding applications or registrations in various other countries.

The TwinCAT Technology is covered, including but not limited to the following patent applications and patents: EP0851348, US6167425 with corresponding applications or registrations in various other countries.

1.1.4 Copyright

© Beckhoff Automation GmbH & Co. KG.

The reproduction, distribution and utilization of this document as well as the communication of its contents to others without express authorization are prohibited. Offenders will be held liable for the payment of damages. All rights reserved in the event of the grant of a patent, utility model or design.

1.1.5 State at Delivery





All the components are supplied in particular hardware and software configurations appropriate for the application. Modifications to hardware or software configurations other than those described in the documentation are not permitted, and nullify the liability of Beckhoff Automation GmbH & Co. KG.

1.1.6 Delivery conditions

In addition, the general delivery conditions of the company Beckhoff Automation GmbH & Co. KG apply.

1.2 Description of safety symbols

The following safety symbols are used in this operating manual. They are intended to alert the reader to the associated safety instructions.

 DANGER	<p>Acute risk of injury!</p> <p>If you do not adhere the safety advise adjoining this symbol, there is immediate danger to life and health of individuals!</p>
 WARNING	<p>Risk of injury!</p> <p>If you do not adhere the safety advise adjoining this symbol, there is danger to life and health of individuals!</p>
 CAUTION	<p>Hazard to individuals!</p> <p>If you do not adhere the safety advise adjoining this symbol, there is obvious hazard to individuals!</p>
 Attention	<p>Hazard to devices and environment</p> <p>If you do not adhere the notice adjoining this symbol, there is obvious hazard to materials and environment.</p>
 Note	<p>Note or pointer</p> <p>This symbol indicates information that contributes to better understanding.</p>

1.3 Operator's obligation to exercise diligence

The operator must ensure that

- the product is only used as intended (see chapter [Product Description](#))
- the product is in a sound condition and in working order during operation (see chapter [Maintenance](#))
- the product is operated, maintained and repaired only by suitably qualified and authorized personnel
- the personnel is instructed regularly about relevant occupational safety and environmental protection aspects, and is familiar with the operating manual and in particular the safety notes contained herein
- the operation manual is in good condition and complete, and always available for reference at the location of the product
- none of the safety and warning notes attached to product are removed, and that all notes remain legible.

2 Product Description

2.1 Product Overview



The Beckhoff CU8801-0000 USB2.0-Extender-Tx allows to extend the limits of USB cable length. Standard USB cable are specified for cable length up to 5 meters. For some industrial applications there is need for longer distances. This box can extend the distance up to 50 meters. This box sends the USB signals from input port to the receiver unit. Other outstanding features are:

- User-friendly installation via integrated DIN rail adapter
- No power supply needed – the box is supplied by USB (5V DC)
- 480 Mbit, 12 Mbit, and 1.5 Mbit support for compatibility to USB2.0 standard
- Standard CAT5 network cable for extension
- Compact industrial design.

2.2 Connections

2.2.1 Power Supply

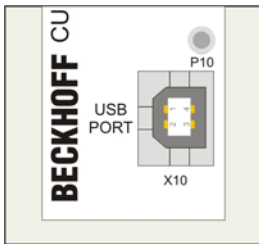

The USB2.0-Extender-Tx does not need any additional power supply. The power supply (5 V DC) is realized by the USB connector. The LED **P10** lights green when power supply is connected.

 Note	<p>First establish USB connection</p> <p>The USB connection between the Industrial PC and the CU8801-0000 should be established before switching the PC on, otherwise over-current messages can be displayed.</p>
--	--

 Attention	<p>UL Requirements</p> <p>To meet the UL requirements, the USB hub CU8801-0000 must not be connected to unlimited power sources!</p>
--	---

2.2.2 Data Connections

There are two kind of connectors: USB Port type B and RJ45 connector. The pins are described below:

USB type B Port (X10) (standard cable)

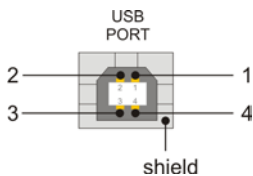

Pin	Assignment
1	VCC
2	Data -
3	Data +
4	GND
Shield	Shield

RJ 45 Port (X20) (standard CAT5 cable)

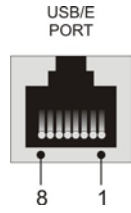

Pin	Assignment
1	MX0+
2	MX0-
3	MX1+
4	MX1-
5	MX2+
6	MX2-
7	MX3+
8	MX3-

2.3 LED-Diagnostics

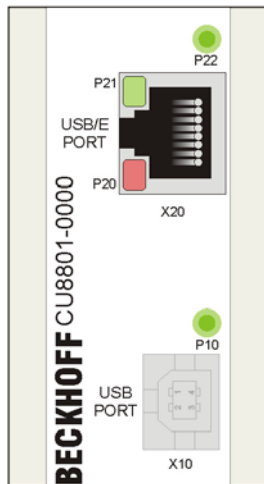

LED	Allocation	State	Meaning
P10	Power supply	off	no power supply
		lights green	5 V _{DC} connected via USB-Port
P20	Connection	off	no connection
		lights green	USB connection established between transmitter and receiver
P21	Activity	off	no data traffic
		lights yellow	data traffic between USB device and Host
P22	Host	off	no USB device connected or not identified
		lights green	connected USB device identified from Host

3 Installation

3.1 Transport and Unpacking

The specified storage conditions must be observed (see chapter [Technical Data](#)).

3.1.1 Transport

Despite the robust design of the unit, the components are sensitive to strong vibrations and impacts. During transport, the unit should therefore be protected from excessive mechanical stress. Therefore, please use the original packaging.

	Danger of damage to the unit
Attention	If the device is transported in cold weather or is exposed to extreme variations in temperature, make sure that moisture (condensation) does not form on or inside the device.

Prior to operation, the unit must be allowed to slowly adjust to room temperature. Should condensation occur, a delay time of approximately 12 hours must be allowed before the unit is switched on.

3.1.2 Unpacking

Proceed as follows to unpack the unit:

1. Remove packaging
2. Do not discard the original packaging. Keep it for future relocation
3. Check the delivery for completeness by comparing it with your order
4. Please keep the associated paperwork. It contains important information for handling the unit
5. Check the contents for visible shipping damage.

If you notice any shipping damage or inconsistencies between the contents and your order, you should notify Beckhoff Service.

3.2 Mounting/ Demounting

The USB-Extender-Tx CU8801-0000 can be snapped onto a 35 mm mounting rail conforms to EN 50022:

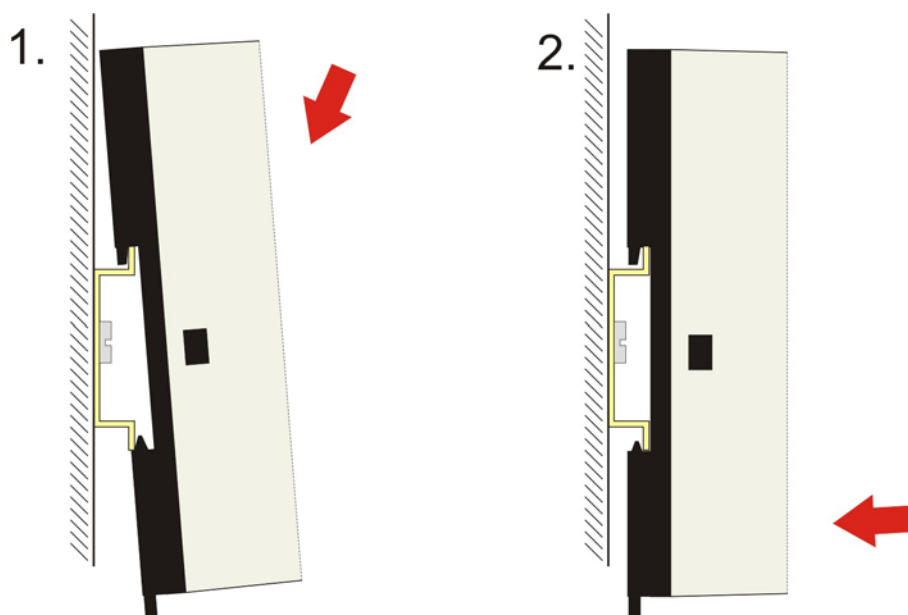

To release the CU8801-0000 from the mounting rail:

1. first pull the lug at the bottom of the hub downwards by using a screw driver (1)
2. then pull the hub from the mounting rail (2).

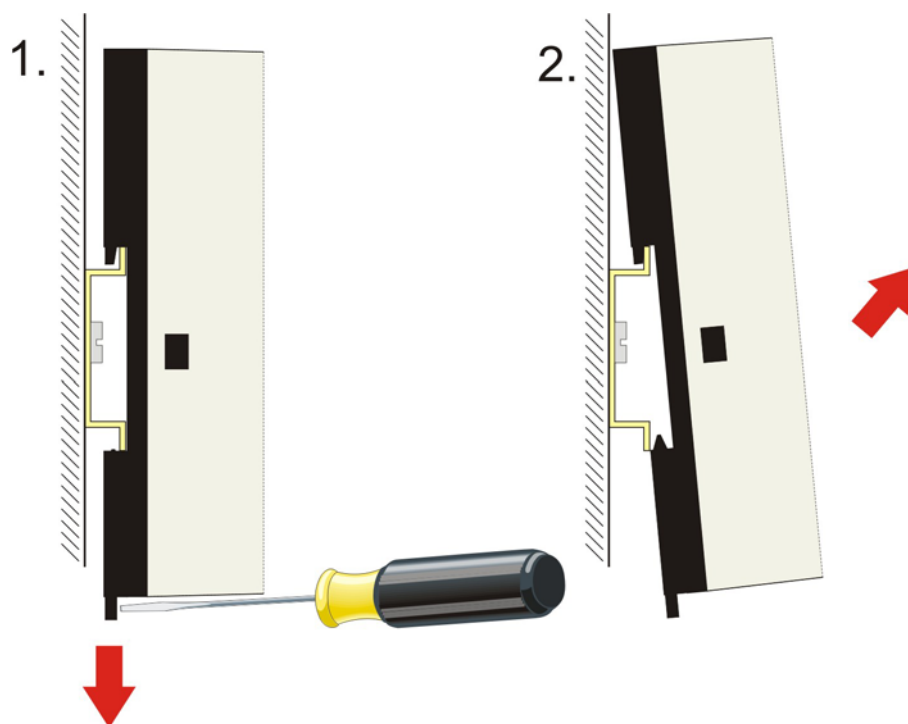

3.3 Connecting devices

	<p>The power supply plug must be withdrawn</p> <p>Please read the documentation for the external devices prior to connecting them!</p> <p>During thunderstorms, plug connector must neither be inserted nor removed!</p> <p>When disconnecting a plug connector, always handle it at the plug. Do not pull the cable!</p>
---	--

Attention

The power supply plug must be withdrawn

Please read the documentation for the external devices prior to connecting them!

During thunderstorms, plug connector must neither be inserted nor removed!

When disconnecting a plug connector, always handle it at the plug. Do not pull the cable!

3.3.1 Connecting cables

The connections are documented in the section [Product Description](#).

When connecting the cables to the CU8801-0000, proceed according to the following sequence:

- Switch off all the devices that are to be connected
- Disconnect all the devices that are to be connected from the power supply
- Connect all the cables between the CU8801-0000 and the devices that are to be connected
- Reconnect all devices to the power supply.

3.3.2 Connecting Power Supply

The power supply is realized by the USB connector.

	<p>First establish USB connection</p> <p>The USB connection between the Industrial PC and the CU8801-0000 should be established before switching the PC on, otherwise over-current messages can be displayed.</p>
---	--

Note

First establish USB connection

The USB connection between the Industrial PC and the CU8801-0000 should be established before switching the PC on, otherwise over-current messages can be displayed.

4 Operation

4.1 Architecture Description

Within the USB2.0-Extender-Tx (CU8801) and USB2.0-Extender-Rx (CU8851) the length of USB data transmission can be increased.

The following pictures show the possible configurations with the maximum length of connection.

4.1.1 Configuration 1

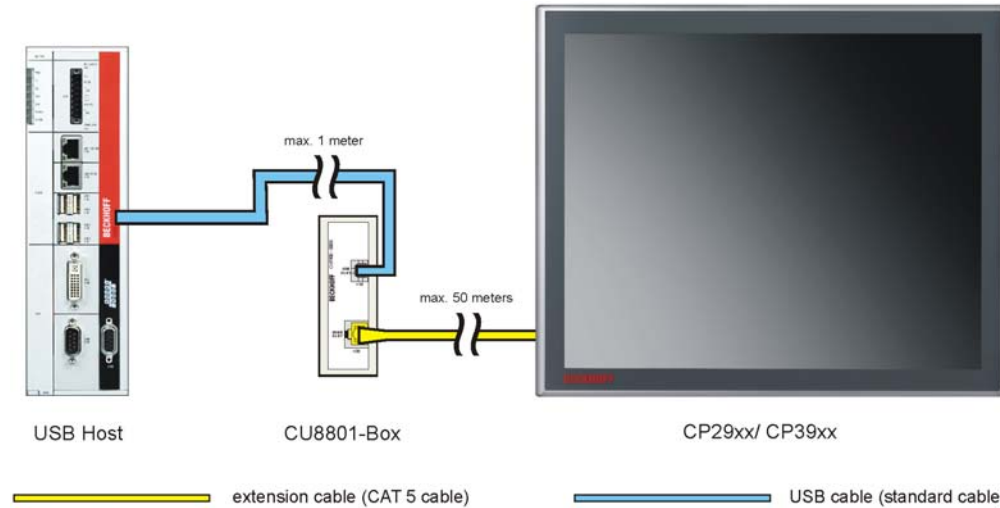

This configuration shows a CP29xx/ CP39xx Control Panel connected to the CU8801 extension box. The maximum distance from the host computer to the CU8801 extension box is 1 meter, the maximum cable length between the CU8801 extension box and the Control Panel is 50 meters.

There is a hub integrated in the Control Panel, so connecting an additional USB hub to the USB connector of the Control Panel is not possible. Connecting a keyboard with an integrated hub is not either possible.

4.1.2 Configuration 2

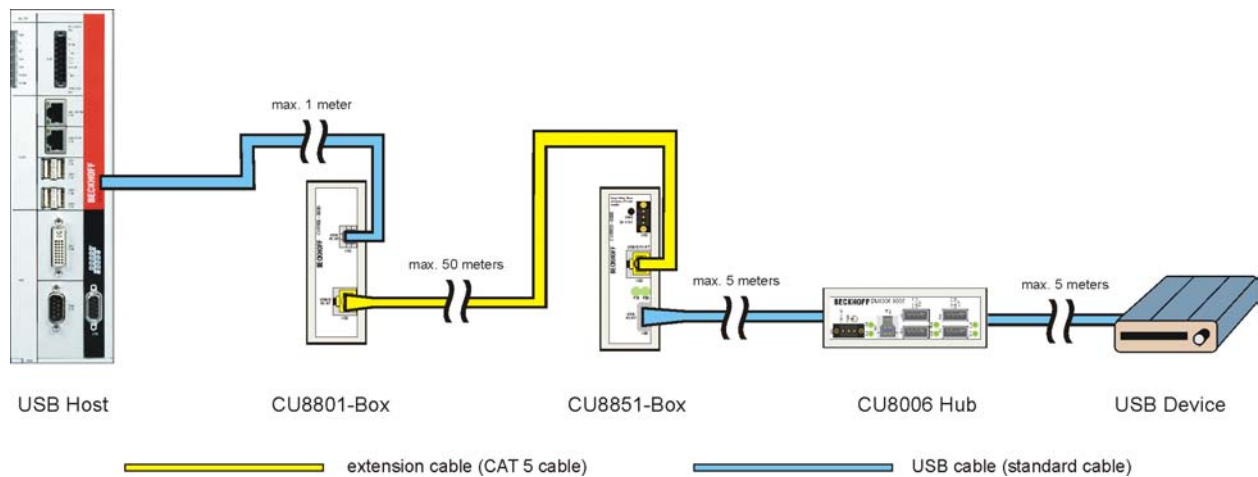

The USB hub is connected after the extension. It is absolutely necessary to connect a CU8006 Hub behind the CU8851-Box. Due to the USB signal runtime, it is not possible to connect more than one CU8006-USB Hub in the chain. Connecting additional hubs or multimedia keyboards with integrated hubs is not either possible.

The maximum cable lengths are: From the host computer to the CU8801-USB extension box maximum 1 m, maximum 50 meters extension cable, maximum 5 meters from the extension box to the CU8006-USB hub and maximum 5 meters from the CU8006-USB hub to the USB device.

4.2 Maintenance

4.2.1 Cleaning

 DANGER	Disconnect power supply Switch off the device and all connected devices, and disconnect the device from the power supply.
--	---

The device can be cleaned with a soft, damp cloth. Do not use any aggressive cleaning materials, thinners, scouring material or hard objects that could cause scratches.

4.2.2 Maintenance

The CU8801-0000 USB2.0-Extender-Tx is maintenance-free.

4.3 Shutting down

4.3.1 Disposal

 Note	Observe national electronics scrap regulations Observe the national electronics scrap regulations when disposing of the device.
---	---

In order to dispose of the device, it must be removed and fully dismantled:

- Housing components (polycarbonate, polyamide (PA6.6)) are suitable for plastic recycling
- Metal parts can be sent for metal recycling
- Electronic parts such as disk drives and circuit boards must be disposed of in accordance with national electronics scrap regulations.

5 Dimensions

The product is characterized by small overall installed size. With a height of 100 mm, the module dimensions exactly match those of the Beckhoff Bus Terminals. Together with the lowered connector surfaces, this means that it can be used in a standard terminal box with a height of 120 mm.

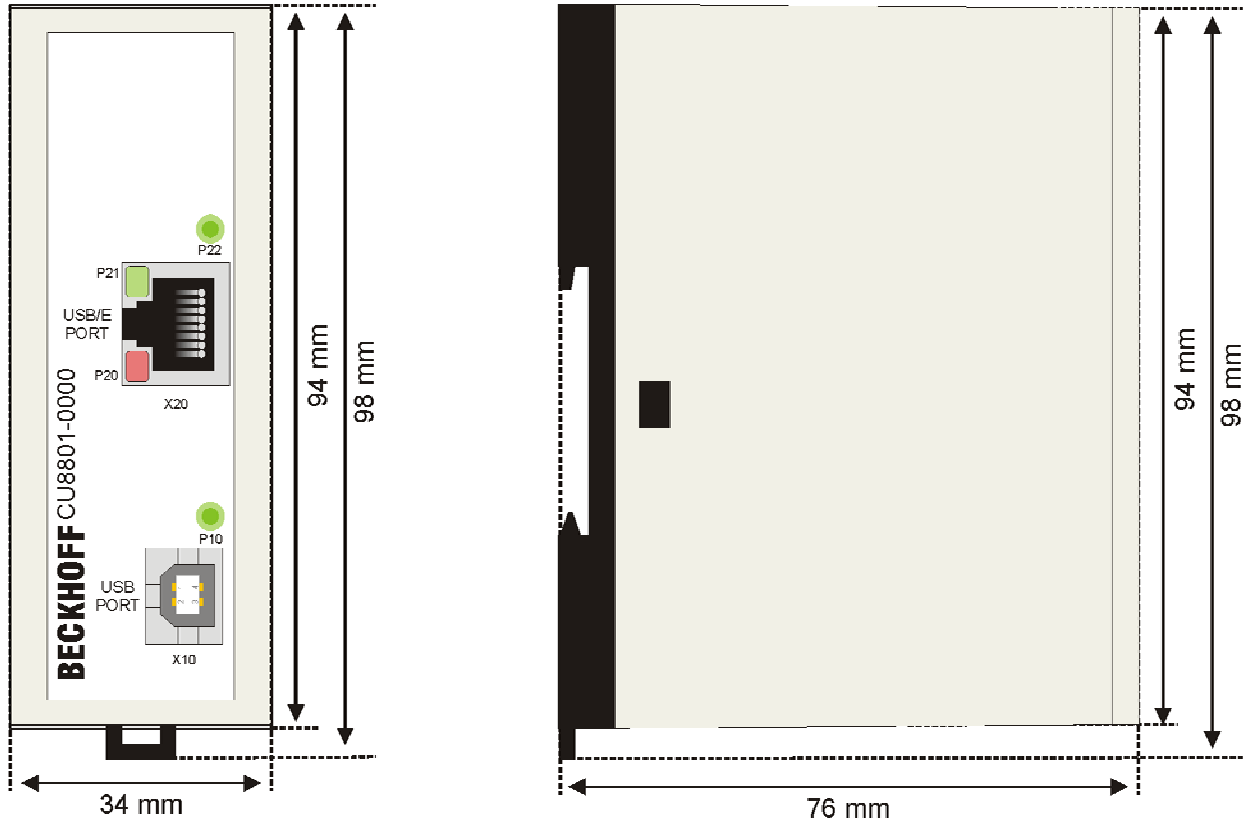

6 Technical Data

Product name	CU8801-0000
Number of USB type B ports (upstream)	1
Number of USB–Extender-Tx ports (RJ45)	1
Supported standard	USB 2.0 backward compatible
Supported baud rates USB	480 Mbit, 12 Mbit, 1.5 Mbit
Status display	4 LEDs
USB extension wiring length	maximum 50 meters
USB wiring length	maximum 1 meter
Power supply	by USB (5 V DC)
Max. current input from 5 V USB	maximum 500 mA @ 5 V DC
Current consumption from 5 V USB	maximum 25 mA @ 5 V DC
Current output over USB/E	maximum 150 mA @ 15 V DC
Dimensions (W x H x D)	app. 34 mm x 100 mm x 76 mm (with lug for mounting rail release)
Weight	app. 95 g
Permissible ambient temperature	0°C to +55°C (operation) -25°C to +70°C (transport/ storage)
Permissible relative humidity	5% to 95%, no condensation
EMC resistance burst / ESD	EN 60000-6-2 / EN 60000-6-4
Vibration / Shock resistance	EN 60068-2-6 / EN 60068-2-27
Assembly	on 35 mm mounting rail conforms to EN 50022
Installation position	any
Protection class	IP20
Approvals	CE, UL (in preparation)

7 Appendix

7.1 Beckhoff Support and Service

Beckhoff and their partners around the world offer comprehensive support and service, making available fast and competent assistance with all questions related to Beckhoff products and system solutions.

7.1.1 Beckhoff branches and partner companies

Please contact your Beckhoff branch office or partner company for [local support and service](#) on Beckhoff products!

The contact addresses for your country can be found in the list of Beckhoff branches and partner companies: www.beckhoff.com. You will also find further [documentation](#) for Beckhoff components there.

7.1.2 Beckhoff company headquarters

Beckhoff Automation GmbH & Co. KG
Huelshorstweg 20
33415 Verl
Germany

Phone: + 49 (0) 5246/963-0
Fax: + 49 (0) 5246/963-198
E-mail: info@beckhoff.de
Web: <http://www.beckhoff.de/>

Beckhoff Support

Support offers you comprehensive technical assistance, helping you not only with the application of individual Beckhoff products, but also with other, wide-ranging services:

- world-wide support
- design, programming and commissioning of complex automation systems
- and extensive training program for Beckhoff system components

Hotline: + 49 (0) 5246/963-157
Fax: + 49 (0) 5246/963-9157
E-mail: support@beckhoff.com

Beckhoff Service

The Beckhoff Service Center supports you in all matters of after-sales service:

- on-site service
- repair service
- spare parts service
- hotline service

Hotline: + 49 (0) 5246/963-460
Fax: + 49 (0) 5246/963-479
E-mail: service@beckhoff.com

If servicing is required, please quote the **project number** of your product.

7.2 Approvals for USA and Canada

7.3 FCC Approval for USA

FCC: Federal Communications Commission Radio Frequency Interference Statement

This equipment has been tested and found to comply with the limits for a Class A digital device, pursuant to Part 15 of the FCC Rules. These limits are designed to provide reasonable protection against harmful interference when the equipment is operated in a commercial environment. This equipment generates, uses, and can radiate radio frequency energy and, if not installed and used in accordance with the instruction manual, may cause harmful interference to radio communications. Operation of this equipment in a residential area is likely to cause harmful interference in which case the user will be required to correct the interference at his own expense.



Note

Technical modifications

Technical modifications to the device may cause the loss of the FCC approval.

7.4 FCC Approval for Canada

FCC: Canadian Notice

This equipment does not exceed the Class A limits for radiated emissions as described in the Radio Interference Regulations of the Canadian Department of Communications.