

VF



Couplings for braking systems, ISO 5676 interchange.

Flat face couplings designed to connect the braking circuit of trailers to the hydraulic circuit of agricultural machines. ISO 5676 interchange. Some special versions equipped with an additional safety sleeve (VFS) or with an hydraulic lock (VFB) to prevent accidental disconnections are available in the range.



Applications

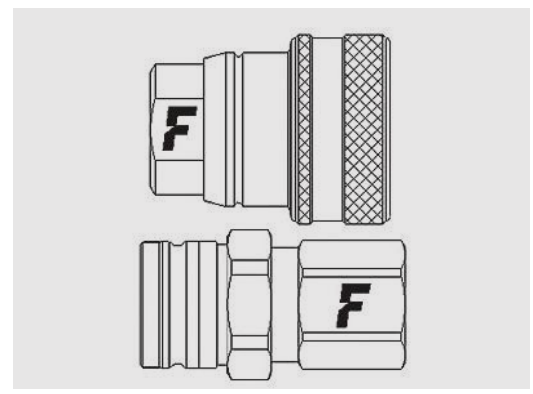

Technical Specifications

dash	Size		Working Pressure (MPa)	Flow Rate (l/min)	Spillage (ml)	Force to Connect (N)	Burst pressure (MPa)		
	mm	inch					Male	Female	Male + Female
06	10	3/8"	22*	40	0,05	100	90	30	110

* Only male connected

Material	Steel
Seals	NBR
Working temperatures	- 25 °C to + 125 °C
Surface treatment	MATE 500 (CrIII)
Series Interchange	ISO 5676
Valve Type	Flat
Connection	Sleeve Retraction
Disconnection	Sleeve Retraction
Connection Under Pressure	Not Allowed

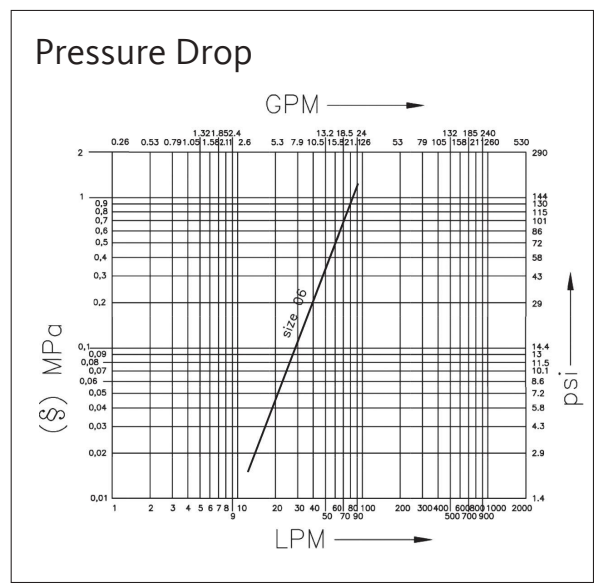

VF

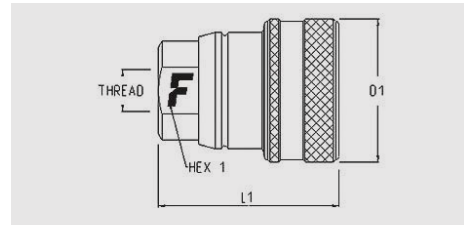

Size		Thread details			FEMALE						
inch	mm	Thread Type	Standard	Thread	Part Number	L (L1 + Thread)		D1		HEX1	
						mm	inch	mm	inch	mm	inch
3/8"	10	F BSPP	ISO 1179-1	BSPP 1/2 FEMALE	VFB 12 GAS F	84	3,31	44	1,73	27	1,06
3/8"	10	F BSPP	ISO 1179-1	BSPP 3/8 FEMALE	VFB 38 GAS F	84	3,31	44	1,73	27	1,06
3/8"	10	O/ BSPP	BS 5380	BSPP 1/2 FEMALE ORB	VF 0/12 GAS F	59	2,32	44	1,73	27	1,06
3/8"	10	F BSPP	ISO 1179-1	BSPP 3/8 FEMALE	VF 38 GAS F	55	2,17	44	1,73	27	1,06
3/8"	10	F BSPP	ISO 1179-1	BSPP 3/8 FEMALE	VFS 38 GAS F	55	2,17	44	1,73	27	1,06
3/8"	10	F METRIC	ISO 9974-1	M18x1,5 FEMALE	VF 1815 F	55	2,17	44	1,73	27	1,06
3/8"	10	F METRIC	ISO 9974-1	M18x1,5 FEMALE	VFS 1815 F	55	2,17	44	1,73	27	1,06

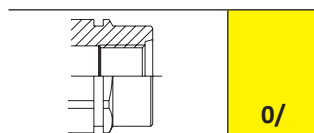
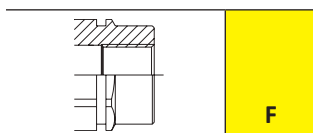

VF

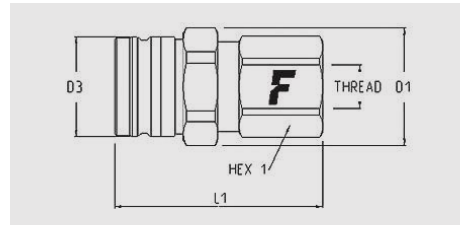

Size		Thread details			MALE								
inch	mm	Thread Type	Standard	Thread	Part Number	L (L1 + Thread)		D1		D3		HEX1	
						mm	inch	mm	inch	mm	inch	mm	inch
3/8"	10	01/ BSPP	ISO 1179-3	1/2" BSPP MALE	VF 1/12 GAS M	59	2,32	35	1,38	29	1,14	32	1,26
3/8"	10	01/ METRIC	ISO 6149-2	M18x1,5 MALE	VF 1/1815 M T	57	2,24	35	1,38	29	1,14	32	1,26
3/8"	10	01/ METRIC	ISO 6149-2	M26x1,5 MALE	VFS1/2615 M	44	1,73	35	1,38	29	1,14	32	1,26
3/8"	10	01/ METRIC	ISO 6149-2	M26x1,5 MALE	VFS1/2615 M T	44	1,73	35	1,38	29	1,14	32	1,26
3/8"	10	02/ METRIC	ISO 8434-1-L	M16x1,5 MALE 10L	VF9/1615 M T	54	2,13	35	1,38	29	1,14	32	1,26
3/8"	10	02/ METRIC	ISO 8434-1-L	M18x1,5 MALE 12L	VF9/1815 M T	54	2,13	35	1,38	29	1,14	32	1,26
3/8"	10	02/ METRIC	ISO 8434-1-L	M18x1,5 MALE 12L	VF9/1815 M TD	54	2,13	35	1,38	29	1,14	32	1,26
3/8"	10	04/ BSPP	ISO 8434-6	BSPP 3/8 MALE BULKHEAD	VF4/12GAS M T	74	2,91	35	1,38	29	1,14	32	1,26
3/8"	10	04/ BSPP	ISO 8434-6	BSPP 3/8 MALE BULKHEAD	VF 4/38 GAS MT	75	2,95	35	1,38	29	1,14	32	1,26
3/8"	10	05/ METRIC	ISO 8434-1-L	M22x1,5 MALE BULKHEAD 15L	VF 5/2215 M	59	2,32	35	1,38	29	1,14	32	1,26
3/8"	10	05/ METRIC	ISO 8434-1-L	M22x1,5 MALE BULKHEAD 15L	VF 5/2215 M T	59	2,32	35	1,38	29	1,14	32	1,26
3/8"	10	07/ METRIC	ISO 8434-1-L	M18x1.5 MALE BULKHEAD SHORT 12L	VF 7/1815 M	53	2,09	35	1,38	29	1,14	32	1,26
3/8"	10	07/ METRIC	ISO 8434-1-L	M18x1.5 MALE BULKHEAD SHORT 12L	VF7/1815 M T	53	2,09	35	1,38	29	1,14	32	1,26
3/8"	10	08/ METRIC	ISO 8434-1-S	M20x1.5 MALE BULKHEAD SHORT 12S	VF 8/2015 M	54	2,13	35	1,38	29	1,14	32	1,26
3/8"	10	09/ METRIC	ISO 8434-1 L	M16x1,5 MALE 10L	VF 9/1615 M	54	2,13	35	1,38	29	1,14	32	1,26
3/8"	10	09/ METRIC	ISO 8434-1 L	M18x1,5 MALE 12L	VF 9/1815 M	54	2,13	35	1,38	29	1,14	32	1,26
3/8"	10	12/ SAE	ISO 8434-3	13/16"-16 UN MALE BULKHEAD ORFS	VF 12/12S M T	74	2,91	35	1,38	29	1,14	32	1,26
3/8"	10	14/ SAE	ISO 8434-2	7/8"-14 UNF MALE BULKHEAD JIC	VF 14/58S M	64	2,52	35	1,38	29	1,14	32	1,26
3/8"	10	17/ SAE	ISO 8434-3	11/16"-16 UN MALE ORFS	VFF17/38S M	60	2,36	35	1,38	29	1,14	32	1,26
3/8"	10	17/SAE	ISO 8434-3	11/16"-16 UN MALE ORFS	VFF17/38S M	60	2,36	35	1,38	29	1,14	32	1,26
3/8"	10	F BSPP	ISO 1179-1	BSPP 1/2 FEMALE	VF 12 GAS M	67	2,64	35	1,38	29	1,14	32	1,26

The part numbers ending with "T" are provided with caps

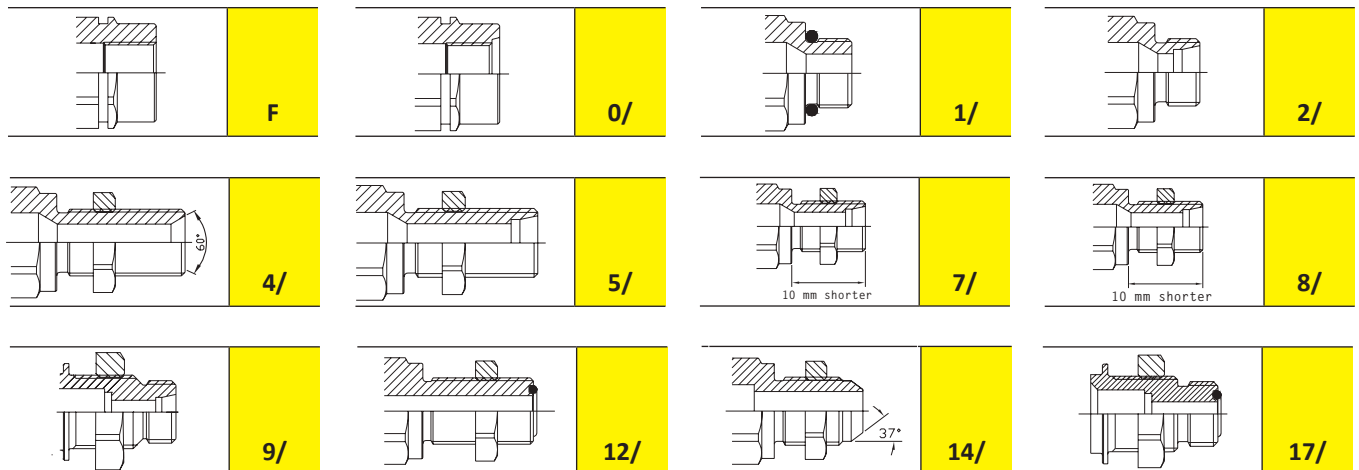

VF accessories

PVC dust caps



Caps suitable for MALE

Size			Cap Details	
inch	mm	dash	Part number	Colour
3/8"	10	06	TFVF	green
3/8"	10	06	TFVF B	blue
3/8"	10	06	TFVF G	yellow
3/8"	10	06	TFVF N	black
3/8"	10	06	TFVF R	red