

# CVV



## Screw-to-connect couplings, ISO 14541 interchange.

Screw-on couplings suitable for general purpose applications. Connectable under residual pressure. High resistance to pressure and flow impulses. Interchangeable according to ISO 14541 standard for size: 1/4"; 3/8"; 1/2"; 3/4".



## Applications

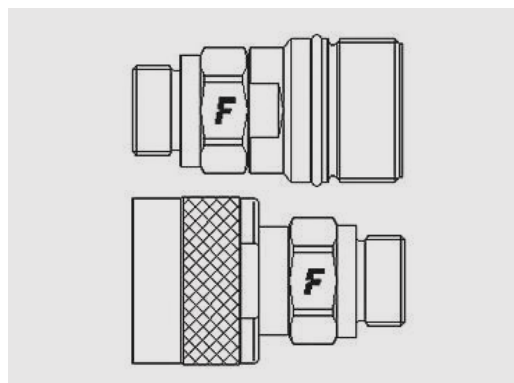

## Technical Specifications

dash	Size mm	inch	Working Pressure* (MPa)	Flow Rate (l/min)	Spillage (ml)	Force to Connect (N)	Burst pressure (MPa)		
							Male	Female	Male + Female
04	6,3	1/4"	37	13	0,8	0	150	160	190
06	10	3/8"	30	25	1,3	0	120	130	170
08	12,5	1/2"	30	65	1,8	0	120	140	140
12	20	3/4"	27	100	8	0	110	120	130
16	25	1"	27	205	13	0	110	130	140
24	37,5	1-1/2"	27	450	34	0	110	110	100

\* Working Pressure according to ISO 14541, that requires a safety factor 4:1 on Minimum Burst Pressure. The coupling can perfectly work with a safety factor 3:1 and consequently with higher Working Pressure.

Material	<b>Steel</b>
Seals	<b>NBR; VITON**</b>
Working temperatures	<b>- 25 °C to + 125 °C</b>
Surface treatment	<b>MATE 500 (CrIII)</b>
Series Interchange	<b>MARKET; ISO 14541</b>
Valve Type	<b>Poppet</b>
Connection	<b>Screw to Connect</b>
Disconnection	<b>Unscrew to Disconnect</b>
Connection Under Pressure	<b>Allowed Residual</b>

\*\* Working temperatures: - 20 °C to + 200 °C

## Pressure Drop

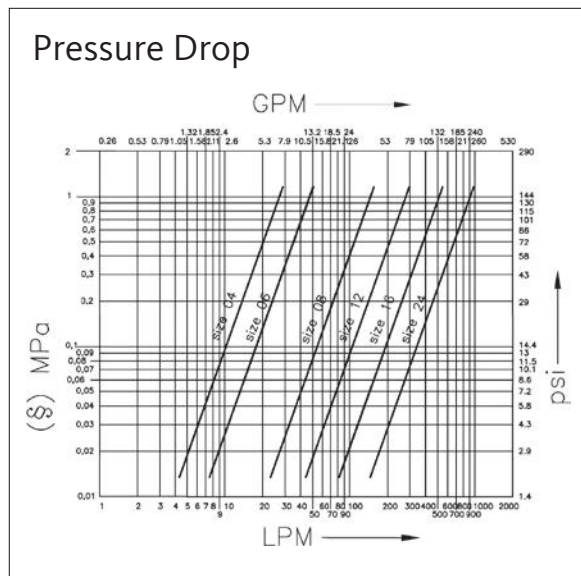

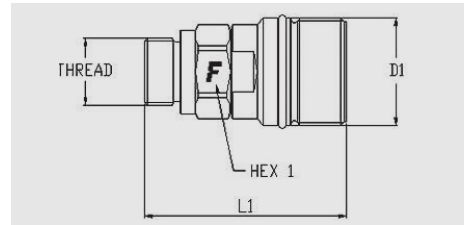

Size		Thread details			FEMALE						
inch	mm	Thread Type	Standard	Thread	Part Number	L (L1 + Thread)		D1		HEX1	
						mm	inch	mm	inch	mm	inch
1/4"	6,3	07/ METRIC	ISO 8434-1-L	M12x1,5 MALE BULKHEAD SHORT 6L	CVV047/1215 F	74	2,91	24	0,94	19	0,75
1/4"	6,3	07/ METRIC	ISO 8434-1-L	M14x1,5 MALE BULKHEAD SHORT 8L	CVV047/1415 F	74	2,91	24	0,94	19	0,75
1/4"	6,3	07/ METRIC	ISO 8434-1-L	M18x1.5 MALE BULKHEAD SHORT 12L	CVV047/1815 F	74	2,91	24	0,94	22	0,87
1/4"	6,3	12/ SAE	ISO 8434-3	13/16"-16 UN MALE BULKHEAD ORFS	CVV0412/12S F	82,5	3,25	24	0,94	24	0,94
1/4"	6,3	27/ SAE	ISO 8434-3	9/16"-18 UNF FEMALE ORFS	CVV0427/14SAEF	62	2,44	24	0,94	19	0,75
1/4"	6,3	F BSPP	ISO 1179-1	BSPP 1/4 FEMALE	CVV04 14 GAS F	63	2,48	24	0,94	19	0,75
3/8"	10	02/ METRIC	ISO 8434-1-L	M16x1,5 MALE 10L	CVV062/1615 F	68	2,68	28	1,1	24	0,94
3/8"	10	05/ METRIC	ISO 8434-1-L	M16x1,5 MALE BULKHEAD 10L	CVV065/1615 F	92	3,62	28	1,1	24	0,94
3/8"	10	07/ METRIC	ISO 8434-1-L	M18x1.5 MALE BULKHEAD SHORT 12L	CVV067/1815 F	83	3,27	28	1,1	24	0,94
3/8"	10	F BSPP	ISO 1179-1	BSPP 3/8 FEMALE	CVV06 38 GAS F	71	2,8	28	1,1	24	0,94
1/2"	12,5	0/ BSPP	BS 5380	BSPP 1/2 FEMALE ORB	CVV080/12GAS FV	61	2,4	36	1,42	27	1,06
1/2"	12,5	0/ BSPP	BS 5380	BSPP 3/8 FEMALE ORB	CVV080/38GAS FV	57	2,24	36	1,42	27	1,06
1/2"	12,5	0/ METRIC	ISO 6149-1	M22x1,5 FEMALE ORB	CVV080/2215 FV	61	2,4	36	1,42	27	1,06
1/2"	12,5	0/ SAE	ISO 11926-1	3/4"-16 UNF FEMALE ORB	CVV080/12SAE FV	61	2,4	36	1,42	27	1,06
1/2"	12,5	02/ METRIC	ISO 8434-1-L	M16x1,5 MALE 10L	CVV082/1615 FV	59	2,32	36	1,42	27	1,06
1/2"	12,5	02/ METRIC	ISO 8434-1-L	M18x1,5 MALE 12L	CVV082/1815 FV	57	2,24	36	1,42	27	1,06
1/2"	12,5	02/ METRIC	ISO 8434-1-L	M22x1,5 MALE 15L	CVV082/2215 FV	58	2,28	36	1,42	27	1,06
1/2"	12,5	02/ METRIC	ISO 8434-1-L	M26x1,5 MALE 18L	CVV082/2615 FV	58	2,28	36	1,42	27	1,06
1/2"	12,5	03/ METRIC	ISO 8434-1-S	M20x1.5 MALE 12S	CVV083/2015 FV	58	2,28	36	1,42	27	1,06
1/2"	12,5	03/ METRIC	ISO 8434-1-S	M22x1.5 MALE 14S	CVV083/2215 FV	60	2,36	36	1,42	27	1,06
1/2"	12,5	03/ METRIC	ISO 8434-1-S	M24x1,5 MALE 16S	CVV083/2415 FV	60	2,36	36	1,42	27	1,06
1/2"	12,5	05/ METRIC	ISO 8434-1-L	M16x1,5 MALE BULKHEAD 10L	CVV085/1615 FV	81	3,19	36	1,42	27	1,06
1/2"	12,5	05/ METRIC	ISO 8434-1-L	M18x1,5 MALE BULKHEAD 12L	CVV085/1815 FV	81	3,19	36	1,42	27	1,06
1/2"	12,5	05/ METRIC	ISO 8434-1-L	M22x1,5 MALE BULKHEAD 15L	CVV085/2215 FV	81	3,19	36	1,42	27	1,06
1/2"	12,5	05/ METRIC	ISO 8434-1-L	M26x1,5 MALE BULKHEAD 18L	CVV085/2615 FV	81	3,19	40	1,57	27	1,06
1/2"	12,5	06/ METRIC	ISO 8434-1-S	M24x1.5 MALE BULKHEAD 16S	CVV086/2415 FV	81	3,19	36	1,42	27	1,06
1/2"	12,5	07/ METRIC	ISO 8434-1-L	M18x1.5 MALE BULKHEAD SHORT 12L	CVV087/1815 FV	72	2,83	36	1,42	27	1,06
1/2"	12,5	07/ METRIC	ISO 8434-1-L	M22x1.5 MALE BULKHEAD SHORT 15L	CVV087/2215 FV	72	2,83	36	1,42	27	1,06
1/2"	12,5	27/ SAE	ISO 8434-3	1"-14 UNS FEMALE ORFS	CVV0827/58SAEFV	64	2,52	36	1,42	30	1,18
1/2"	12,5	F BSPP	ISO 1179-1	BSPP 1/2 FEMALE	CVV08 12 GAS FV	61	2,4	36	1,42	27	1,06
1/2"	12,5	F BSPP	ISO 1179-1	BSPP 3/8 FEMALE	CVV08 38 GAS FV	57	2,24	36	1,42	27	1,06

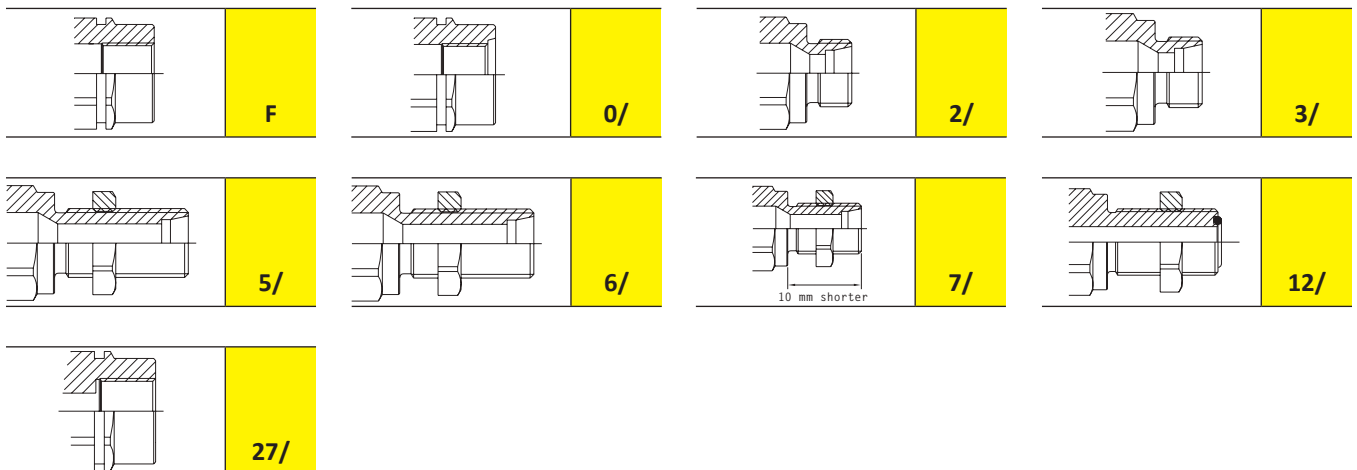

CVV

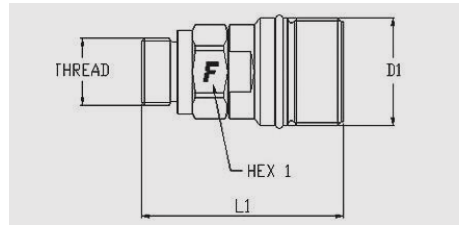

Size		Thread details			FEMALE						
inch	mm	Thread Type	Standard	Thread	Part Number	L (L1 + Thread)		D1		HEX1	
						mm	inch	mm	inch	mm	inch
3/4"	20	O/ SAE	ISO 11926-1	1-1/16"-12 UN FEMALE ORB	CVV120/34SAE FV	83	3,27	42	1,65	38	1,5
3/4"	20	F BSPP	ISO 1179-1	BSPP 3/4 FEMALE	CVV12 34 GAS FV	83	3,27	42	1,65	38	1,5
1"	25	O/ BSPP	BS 5380	BSPP 1 FEMALE ORB	CVV160/1GAS FV	93	3,66	48	1,89	42	1,65
1"	25	O/ BSPP	BS 5380	BSPP 3/4 FEMALE ORB	CVV160/34GAS FV	90	3,54	48	1,89	38	1,5
1"	25	O2/ METRIC	ISO 8434-1-L	M36x2 MALE 28L	CVV162/362 F V	87	3,43	48	1,89	38	1,5
1"	25	O3/ METRIC	ISO 8434-1-S	M30x2 MALE 20S	CVV163/302 F V	92	3,62	48	1,89	38	1,5
1"	25	O3/ METRIC	ISO 8434-1-S	M36x2 MALE 25S	CVV163/362 F V	93	3,66	48	1,89	38	1,5
1"	25	O3/ METRIC	ISO 8434-1-S	M42x2 MALE 30S	CVV163/422 F V	90	3,54	51	2,01	46	1,81
1"	25	O5/ METRIC	ISO 8434-1-L	M26x1,5 MALE BULKHEAD 18L	CVV165/2615 FV	116	4,57	48	1,89	38	1,5
1"	25	O5/ METRIC	ISO 8434-1-L	M30x2 MALE BULKHEAD 22L	CVV165/302 F V	109	4,29	48	1,89	41	1,61
1"	25	O5/ METRIC	ISO 8434-1-L	M36x2 MALE BULKHEAD 28L	CVV165/362 F V	106	4,17	52	2,05	42	1,65
1"	25	O6/ METRIC	ISO 8434-1-S	M30x2 MALE BULKHEAD 20S	CVV166/302 F V	114	4,49	48	1,89	38	1,5
1"	25	O6/ METRIC	ISO 8434-1-S	M36x2 MALE BULKHEAD 25S	CVV166/362 F V	113	4,45	52	2,05	42	1,65
1"	25	O6/ METRIC	ISO 8434-1-S	M42x2 MALE BULKHEAD 30S	CVV166/422 F V	110	4,33	56	2,2	50	1,97
1"	25	11/ SAE	ISO 8434-3	1-11/16"-12 UN MALE ORFS	CVV1611/114S FV	96	3,78	55	2,17	50	1,97
1"	25	11/ SAE	ISO 8434-3	1-7/16"-12 UN MALE ORFS	CVV1611/1SAE FV	96	3,78	55	2,17	50	1,97
1"	25	F BSPP	ISO 1179-1	BSPP 1 FEMALE	CVV16 1 GAS FV	94	3,7	46	1,81	42	1,65
1"	25	F BSPP	ISO 1179-1	BSPP 3/4 FEMALE	CVV16 34 GAS FV	89	3,5	48	1,89	38	1,5
1-1/2"	37,5	O2/ METRIC	ISO 8434-1-L	M45x2 MALE 35L	CVV242/452 F V	111	4,37	70	2,76	55	2,17
1-1/2"	37,5	O3/ METRIC	ISO 8434-1-S	M42x2 MALE 30S	CVV243/422 F V	115	4,53	70	2,76	55	2,17
1-1/2"	37,5	O3/ METRIC	ISO 8434-1-S	M52x2 MALE 38S	CVV243/522 F V	117	4,61	70	2,76	55	2,17
1-1/2"	37,5	O5/ METRIC	ISO 8434-1-L	M45x2 MALE BULKHEAD 35L	CVV245/452 F V	131	5,16	70	2,76	55	2,17
1-1/2"	37,5	O6/ METRIC	ISO 8434-1-S	M42x2 MALE BULKHEAD 30S	CVV246/422 F V	135	5,31	70	2,76	55	2,17
1-1/2"	37,5	O6/ METRIC	ISO 8434-1-S	M52x2 MALE BULKHEAD 38S	CVV246/522 F V	137	5,39	73	2,87	55	2,17
1-1/2"	37,5	F BSPP	ISO 1179-1	BSPP 1-1/2 FEMALE	CVV24 112GAS FV	121	4,76	72	2,83	65	2,56

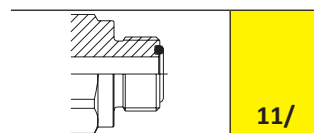
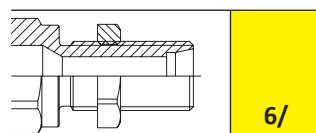
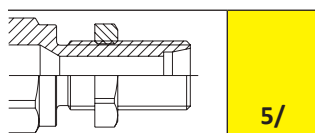
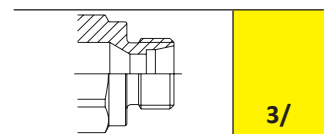
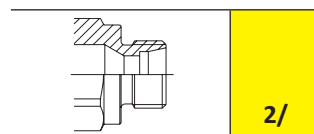
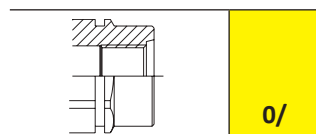
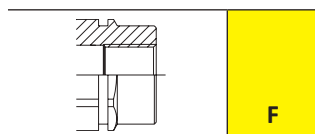

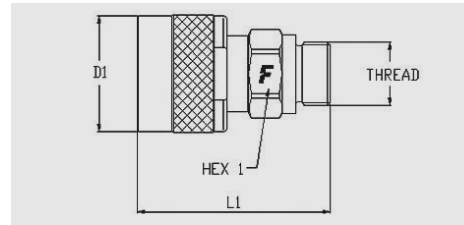

Size		Thread details			MALE								
inch	mm	Thread Type	Standard	Thread	Part Number	L (L1 + Thread)		D1		D3		HEX1	
						mm	inch	mm	inch	mm	inch	mm	inch
1/4"	6,3	02/ METRIC	ISO 8434-1-L	M12x1,5 MALE 6L	CVV042/1215 M	58	2,28	30	1,18			19	0,75
1/4"	6,3	02/ METRIC	ISO 8434-1-L	M14x1,5 MALE 8L	CVV042/1415 M	58	2,28	30	1,18			19	0,75
1/4"	6,3	02/ METRIC	ISO 8434-1-L	M18x1,5 MALE 12L	CVV042/1815 M	59	2,32	30	1,18			22	0,87
1/4"	6,3	11/ SAE	ISO 8434-3	13/16"-16 UN MALE ORFS	CVV0411/12S M	61	2,4	30	1,18			22	0,87
1/4"	6,3	27/ SAE	ISO 8434-3	9/16"-18 UNF FEMALE ORFS	CVV0427/14SAEM	62	2,44	30	1,18			19	0,75
1/4"	6,3	F BSPP	ISO 1179-1	BSPP 1/4 FEMALE	CVV04 14 GAS M	63	2,48	30	1,18			19	0,75
3/8"	10	02/ METRIC	ISO 8434-1-L	M16x1,5 MALE 10L	CVV062/1615 M	66	2,6	34	1,34			24	0,94
3/8"	10	02/ METRIC	ISO 8434-1-L	M18x1,5 MALE 12L	CVV062/1815 M	68	2,68	34	1,34			24	0,94
3/8"	10	F BSPP	ISO 1179-1	BSPP 3/8 FEMALE	CVV06 38 GAS M	70	2,76	34	1,34			24	0,94
1/2"	12,5	0/ BSPP	BS 5380	BSPP 1/2 FEMALE ORB	CVV080/12GAS MV	70	2,76	42	1,65			27	1,06
1/2"	12,5	0/ BSPP	BS 5380	BSPP 3/8 FEMALE ORB	CVV080/38GAS MV	66	2,6	42	1,65			27	1,06
1/2"	12,5	0/ METRIC	ISO 6149-1	M22x1,5 FEMALE ORB	CVV080/2215 MV	70	2,76	42	1,65			27	1,06
1/2"	12,5	0/ SAE	ISO 11926-1	3/4"-16 UNF FEMALE ORB	CVV080/12SAE MV	70	2,76	42	1,65			27	1,06
1/2"	12,5	02/ METRIC	ISO 8434-1-L	M16x1,5 MALE 10L	CVV082/1615 MV	67	2,64	42	1,65			27	1,06
1/2"	12,5	02/ METRIC	ISO 8434-1-L	M18x1,5 MALE 12L	CVV082/1815 MV	66	2,6	42	1,65			27	1,06
1/2"	12,5	02/ METRIC	ISO 8434-1-L	M22x1,5 MALE 15L	CVV082/2215 MV	67	2,64	42	1,65			27	1,06
1/2"	12,5	02/ METRIC	ISO 8434-1-L	M26x1,5 MALE 18L	CVV082/2615 MV	67	2,64	42	1,65			27	1,06
1/2"	12,5	03/ METRIC	ISO 8434-1-S	M20x1.5 MALE 12S	CVV083/2015 MV	67	2,64	42	1,65			27	1,06
1/2"	12,5	03/ METRIC	ISO 8434-1-S	M22x1.5 MALE 14S	CVV083/2215 MV	69	2,72	42	1,65			27	1,06
1/2"	12,5	03/ METRIC	ISO 8434-1-S	M24x1,5 MALE 16S	CVV083/2415 MV	69	2,72	42	1,65			27	1,06
1/2"	12,5	05/ METRIC	ISO 8434-1-L	M18x1,5 MALE BULKHEAD 12L	CVV085/1815 MV	90	3,54	42	1,65			27	1,06
1/2"	12,5	05/ METRIC	ISO 8434-1-L	M22x1,5 MALE BULKHEAD 15L	CVV085/2215 MV	90	3,54	42	1,65			27	1,06
1/2"	12,5	06/ METRIC	ISO 8434-1-S	M22x1.5 MALE BULKHEAD 14S	CVV086/2215 MV	90	3,54	42	1,65			27	1,06
1/2"	12,5	06/ METRIC	ISO 8434-1-S	M24x1.5 MALE BULKHEAD 16S	CVV086/2415 MV	90	3,54	42	1,65			27	1,06
1/2"	12,5	07/ METRIC	ISO 8434-1-L	M18x1.5 MALE BULKHEAD SHORT 12L	CVV087/1815 MV	81	3,19	42	1,65			27	1,06
1/2"	12,5	07/ METRIC	ISO 8434-1-L	M22x1.5 MALE BULKHEAD SHORT 15L	CVV087/2215 MV	81	3,19	42	1,65			27	1,06
1/2"	12,5	27/ SAE	ISO 8434-3	1"-14 UNS FEMALE ORFS	CVV0827/58SAEMV	73	2,87	42	1,65			30	1,18

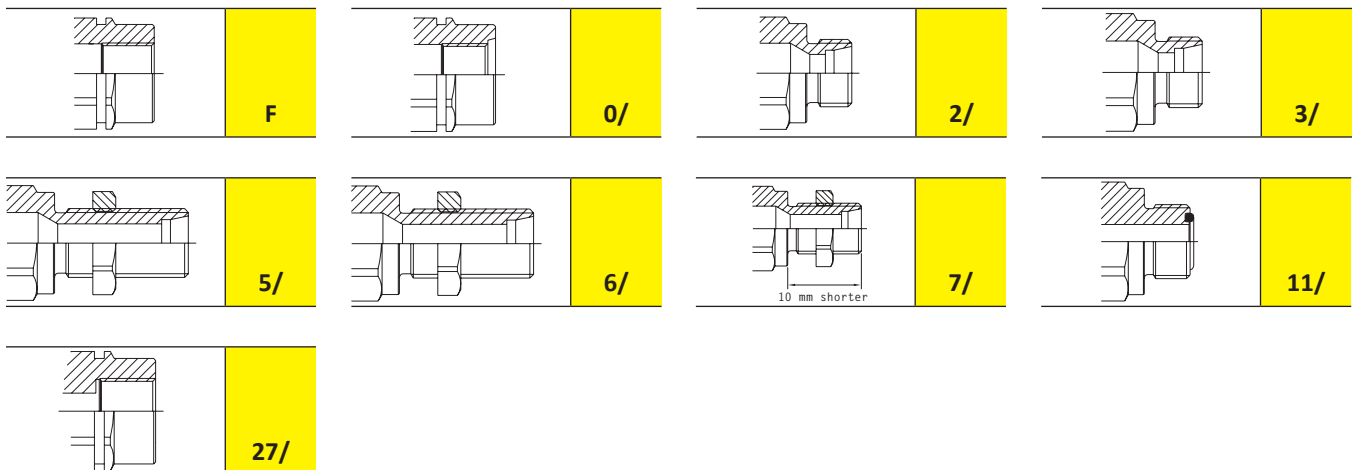

CVV

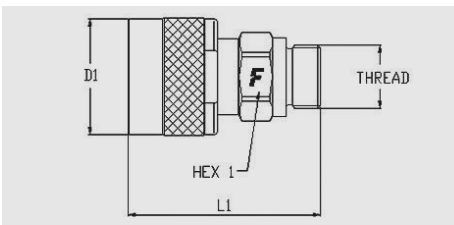

Size		Thread details			MALE								
inch	mm	Thread Type	Standard	Thread	Part Number	L (L1 + Thread)		D1		D3		HEX1	
						mm	inch	mm	inch	mm	inch	mm	inch
1/2"	12,5	F BSPP	ISO 1179-1	BSPP 1/2 FEMALE	CVV08 12 GAS MV	70	2,76	42	1,65			27	1,06
1/2"	12,5	F BSPP	ISO 1179-1	BSPP 3/8 FEMALE	CVV08 38 GAS MV	66	2,6	42	1,65			27	1,06
3/4"	20	O/ SAE	ISO 11926-1	1-1/16"-12 UN FEMALE ORB	CVV120/34SAE MV	86	3,39	48	1,89			38	1,5
3/4"	20	F BSPP	ISO 1179-1	BSPP 3/4 FEMALE	CVV12 34 GAS MV	86	3,39	48	1,89			38	1,5
1"	25	O/ BSPP	BS 5380	BSPP 1 FEMALE ORB	CVV160/1GAS MV	49	1,93	56	2,2			42	1,65
1"	25	O/ BSPP	BS 5380	BSPP 3/4 FEMALE ORB	CVV160/34GAS MV	90	3,54	56	2,2			38	1,5
1"	25	O/ SAE	ISO 11926-1	1-3/16"-12 UN FEMALE ORB	CVV16 78S M V	93	3,66	56	2,2			42	1,65
1"	25	O2/ METRIC	ISO 8434-1-L	M30x2 MALE 22L	CVV162/302 M V	89	3,5	56	2,2			38	1,5
1"	25	O2/ METRIC	ISO 8434-1-L	M36x2 MALE 28L	CVV162/362 M V	88	3,46	56	2,2			38	1,5
1"	25	O3/ METRIC	ISO 8434-1-S	M30x2 MALE 20S	CVV163/302 M V	93	3,66	56	2,2			38	1,5
1"	25	O3/ METRIC	ISO 8434-1-S	M36x2 MALE 25S	CVV163/362 M V	93	3,66	56	2,2			38	1,5
1"	25	O3/ METRIC	ISO 8434-1-S	M42x2 MALE 30S	CVV163/422 M V	90	3,54	56	2,2			38	1,5
1"	25	O5/ METRIC	ISO 8434-1-L	M36x2 MALE BULKHEAD 28L	CVV165/362 M V	107	4,21	56	2,2			42	1,65
1"	25	O6/ METRIC	ISO 8434-1-S	M30x2 MALE BULKHEAD 20S	CVV166/302 M V	115	4,53	56	2,2			38	1,5
1"	25	O6/ METRIC	ISO 8434-1-S	M36x2 MALE BULKHEAD 25S	CVV166/362 M V	113	4,45	56	2,2			42	1,65
1"	25	O6/ METRIC	ISO 8434-1-S	M42x2 MALE BULKHEAD 30S	CVV166/422 M V	110	4,33	56	2,2			50	1,97
1"	25	O11/ SAE	ISO 8434-3	1-11/16"-12 UN MALE ORFS	CVV1611/114S MV	97	3,82	56	2,2			50	1,97
1"	25	O11/ SAE	ISO 8434-3	1-7/16"-12 UN MALE ORFS	CVV1611/1SAE MV	97	3,82	56	2,2			50	1,97
1"	25	F BSPP	ISO 1179-1	BSPP 1 FEMALE	CVV16 1 GAS MV	95	3,74	56	2,2			42	1,65
1"	25	F BSPP	ISO 1179-1	BSPP 3/4 FEMALE	CVV16 34 GAS MV	90	3,54	56	2,2			38	1,5
1-1/2"	37,5	O3/ METRIC	ISO 8434-1-S	M42x2 MALE 30S	CVV243/422 M V	125	4,92	80	3,15			55	2,17
1-1/2"	37,5	O3/ METRIC	ISO 8434-1-S	M52x2 MALE 38S	CVV243/522 M V	127	5	80	3,15			55	2,17
1-1/2"	37,5	O6/ METRIC	ISO 8434-1-S	M52x2 MALE BULKHEAD 38S	CVV246/522 M V	147	5,79	80	3,15			55	2,17
1-1/2"	37,5	F BSPP	ISO 1179-1	BSPP 1-1/2 FEMALE	CVV24 112GAS MV	131	5,16	80	3,15			65	2,56

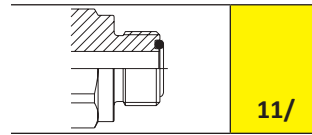
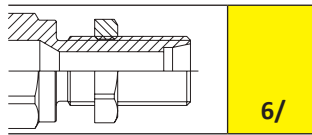
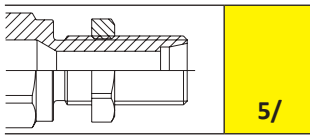
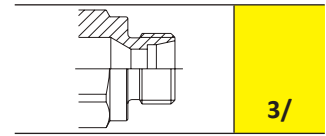
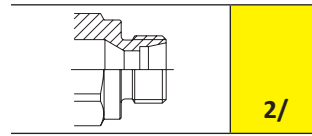
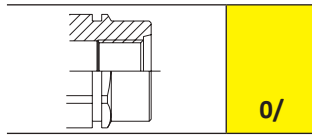
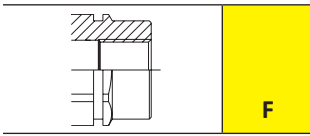

# CVV accessories

## Plastic dust caps



**Caps suitable for FEMALE**



**Plugs suitable for MALE**

Size			Cap Details		Size			Plug Details	
inch	mm	dash	Part number	Colour	inch	mm	dash	Part number	Colour
1/4"	6,3	04	TMVV 04	red	1/4"	6,3	04	TFVV 04	red
3/8"	10	06	TMVV 06	red	3/8"	10	06	TFVV 06	red
1/2"	12,5	08	TMVV 08	red	1/2"	12,5	08	TFVV 08	red
3/4"	20	12	TMVV 12	red	3/4"	20	12	TFVV 12	red
1"	25	16	TMVV 16	red	1"	25	16	TFVV 16	red
1-1/2"	37,5	24	TMVV 24	red	1-1/2"	37,5	24	TFVV 24	red

## Aluminium dust caps



**Caps suitable for FEMALE**

**Caps suitable for MALE**

Size			Cap Details		Size			Cap Details	
inch	mm	dash	Part number	Colour	inch	mm	dash	Part number	Colour
1/4"	6,3	04	TMVV 04 S		1/4"	6,3	04	TFVV 04 S	
3/8"	10	06	TMVV 06 S		3/8"	10	06	TFVV 06 S	
1/2"	12,5	08	TMVV 08 S		1/2"	12,5	08	TFVV 08 S	
1"	25	16	TMVV 16 S		1"	25	16	TFVV 16 S	
1-1/2"	37,5	24	TMVV 24 S		1-1/2"	37,5	24	TFVV 24 S	

## Seal Kits



### For Female

Size			Seal Details	
inch	mm	dash	Material	Part Number
1/4"	3,2	04	NBR; PTFE	SK CVV 04
3/8"	10	06	NBR; PTFE	SK CVV 06
1/2"	12,5	08	FKM; PTFE	SK CVV 08 V
3/4"	20	12	FKM; PTFE	SK CVV 12 V
1"	25	16	FKM; PTFE	SK CVV 16 V
1-1/2"	37,5	24	FKM; PTFE	SK CVV 24 V

Every seals kit is composed of 5 or 10 pcs.