

# Modular Relief Valve

積層型溢流閥

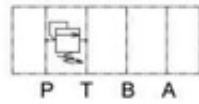

MRV-0\*-P



MRV-0\*-B



MRV-0\*-A

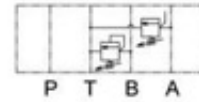

MRV-0\*-W

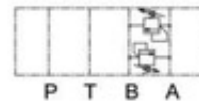

MRV-0\*-D

## 型號說明/HOW TO ORDER

MRV - 02 - P - 1 - K

調節型式：K：旋鈕；無：螺絲調整鈕

Adjusting Type：K：With Knob None：Without

壓力調整範圍 Pressure Adjusting Range

1：8-70 kgf/cm<sup>2</sup>

2：8-140 kgf/cm<sup>2</sup>

3：10-250 kgf/cm<sup>2</sup>

控制孔 Control Port

P：P孔 P port W：A及B孔 A&B port

A：A孔 A port D：T至B和B至A T to B and B to A port

B：B孔 B port D：煞車閥 Brake Valve

通徑 Port Size

02：1/4" 06：3/4"

03：3/8"

積層溢流閥系列 Modular Relief Valve Series

## 規格說明/SPECIFICATIONS

型式 MODEL	最高使用壓力 MAX.PRESSURE kgf/cm <sup>2</sup>	壓力調節範圍 PRESSURE ADJ. RANGE kgf/cm <sup>2</sup>	最大流量 MAX.FLOW LPM	重量 WEIGHT (kg)
MRV-02-P/A/B	250	1：8-70 2：8-140	50	1.7
MRV-02-W/D		3：10-250		2.2
MRV-03-P/A/B	250	1：8-70 2：8-140	100	3.6
MRV-03-W/D		3：10-250		4.8
MRV-06-P/A/B	250	1：8-70 2：8-140 3：10-250	180	12.0

# Modular Relief Valve

## 積層型溢流閥



### 安裝尺寸/INSTALLATION DIMENSIONS

單位 UNIT : mm

#### ■ MRV-02-P.A. B

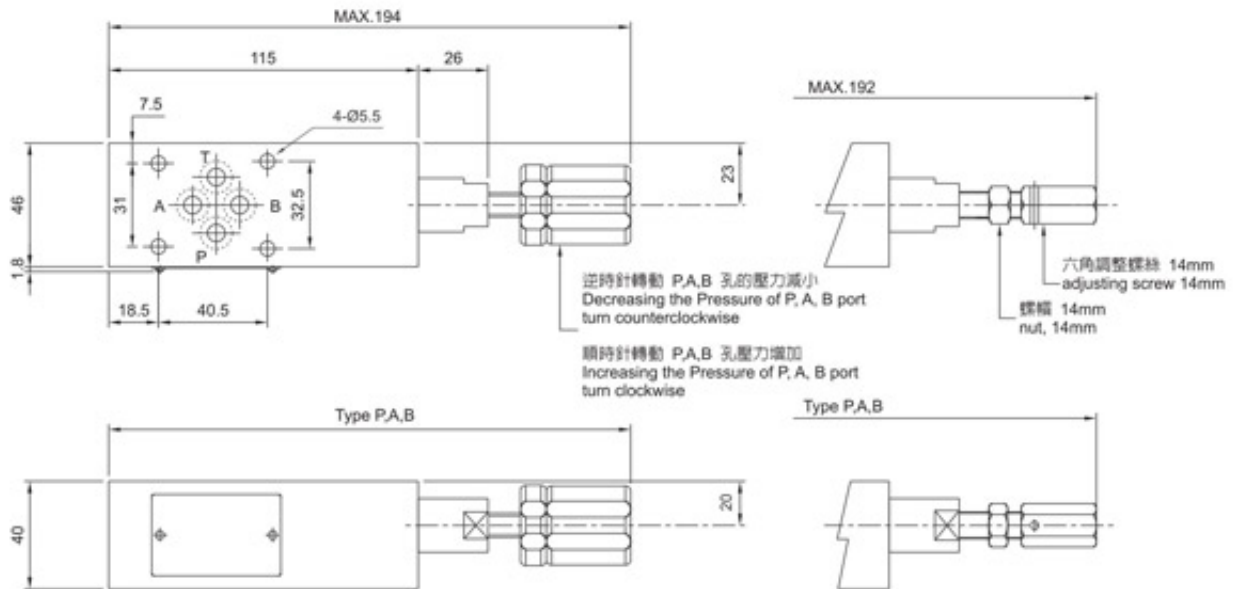

#### ■ MRV-02-W. D

型式 MODEL	A	B	C
MRV-02-W	P51.3	145	MAX.304
MRV-02-D	39	120	MAX.279

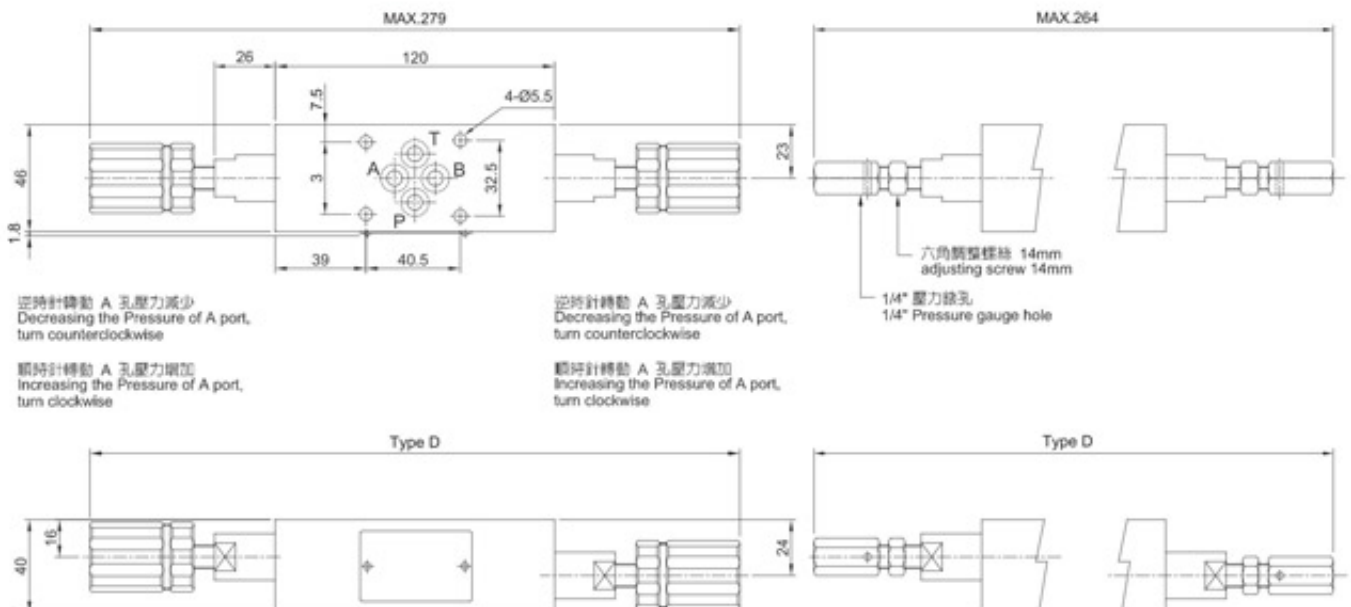

# Modular Relief Valve

## 積層型溢流閥



單位 UNIT : mm

### ■ MRV-03-P.A B

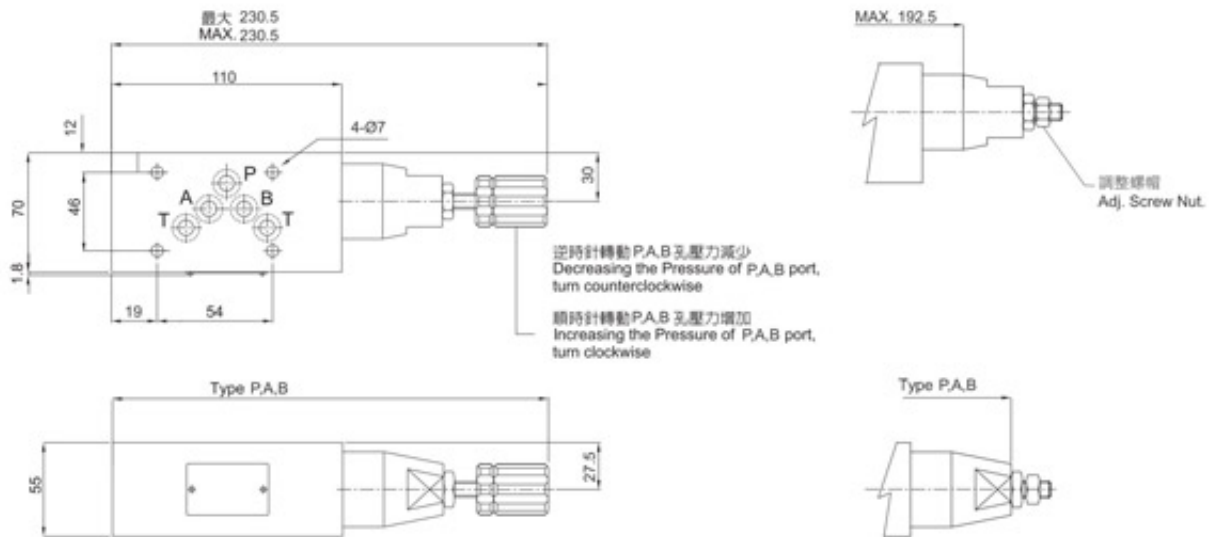

### ■ MRV-03-W. D

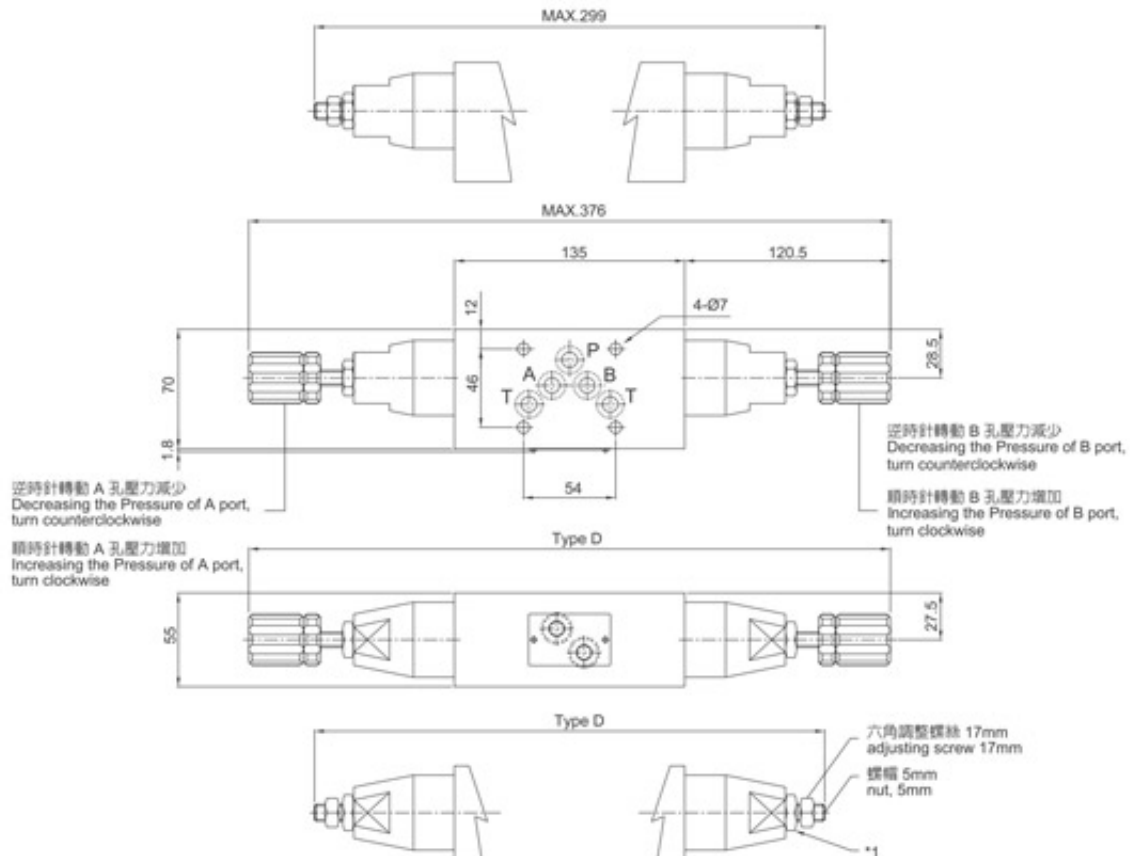

# Modular Relief Valve

## 積層型溢流閥



### 安裝尺寸/INSTALLATION DIMENSIONS

單位 UNIT : mm

#### ■ MRV-06-P. A. B

