

Proportional reducing valves

direct, without transducer

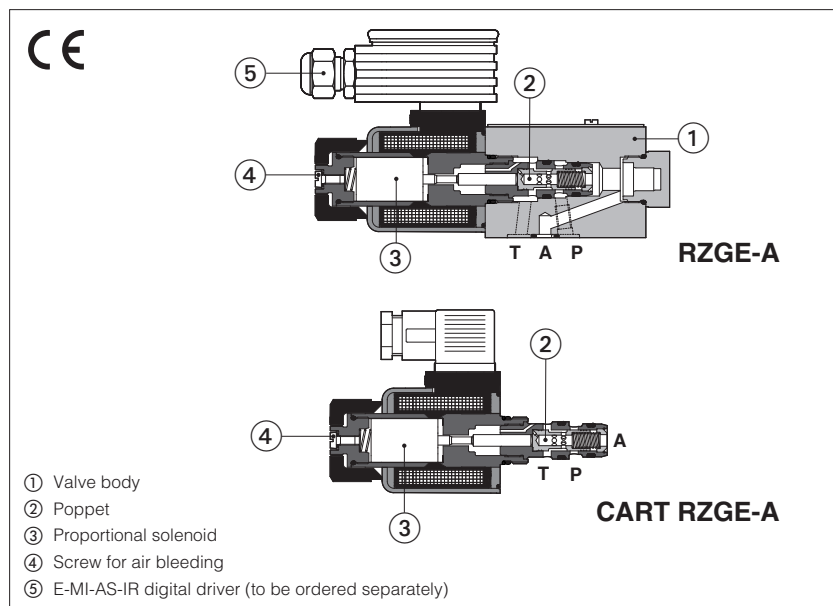

RZGE-A, CART RZGE-A

Poppet type, direct, proportional pressure reducing valves for open loop pressure controls.

They operate in association with off-board driver, which supply the proportional valves with proper current to align the valve regulation to the reference signal supplied to the driver.

They are available in following executions:

RZGE: subplate mounting, ISO size 06

CART RZGE: M20 cartridge execution

The solenoids are certified according to North American standard **cURus**.

Size: **06** - ISO 4401 (RZGE); **M20** (CART RZGE)

Max flow: **12 l/min**

Max pressure: **350 bar**

For cavity CART RZGE see section 16

1 MODEL CODE

RZGE	-	A	-	010	/	210	-	*	/	*	/	*	/	*
<p>Proportional pressure reducing valve, direct</p> <p>RZGE = subplate mounting CART RZGE = cartridge execution</p> <p>A = for off-board driver, see section 3</p> <p>Configuration: 010 = reduced pressure on port A</p> <p>Max regulated pressure: 32 = 32 bar 100 = 100 bar 210 = 210 bar</p>														
<p>Seals material, see section 8: - = NBR PE = FKM BT = HNBR</p> <p>Series number</p> <p>Coil voltage, see section 10: - = standard coil for 24 Vdc Atos drivers 6 = optional coil for 12 Vdc Atos drivers 18 = optional coil for low current drivers (1)</p> <p>Coil with special connectors, see section 12: - = omit for standard DIN connector J = AMP Junior Timer connector K = Deutsch connector S = Lead Wire connection</p>														

(1) Select valve's coil voltage /18 in case of electronic drivers not supplied by Atos, with power supply 24 Vdc and with max current limited to 1A

2 HYDRAULIC SYMBOL

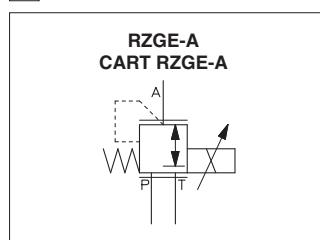

3 OFF-BOARD ELECTRONIC DRIVERS

Drivers model	E-MI-AC-01F (1)		E-MI-AS-IR (1)		E-BM-AS-PS		E-BM-AES
Type	Analog				Digital		
Voltage supply (Vdc)	12	24	12	24	12	24	24
Valve coil option	/6	std	/6	std	/6	std	std
Format	plug-in to solenoid				DIN-rail panel		
Tech table	G010		G020		G030		GS050

(1) For **CART RZGE** the electronic driver may interfere with the manifold surface. Please check the installation dimensions at section 16

4 GENERAL NOTES

Atos digital proportionals valves are CE marked according to the applicable directives (e.g. Immunity and Emission EMC Directive). Installation, wirings and start-up procedures must be performed according to the general prescriptions shown in tech table **FS900** and in the installation notes supply with relevant components.

5 GENERAL CHARACTERISTICS

Assembly position	Any position
Subplate surface finishing to ISO 4401	Acceptable roughness index: Ra ≤ 0,8, recommended Ra 0,4 – Flatness ratio 0,01/100
MTTFd valves according to EN ISO 13849	150 years, see technical table P007
Ambient temperature range	Standard = -20°C ÷ +70°C /PE option = -20°C ÷ +70°C /BT option = -40°C ÷ +60°C
Storage temperature range	Standard = -20°C ÷ +80°C /PE option = -20°C ÷ +80°C /BT option = -40°C ÷ +70°C
Surface protection	Zinc coating with black passivation
Corrosion resistance	Salt spray test (EN ISO 9227) > 200 h
Conformity	CE according to EMC directive 2014/30/EU (Immunity: EN 61000-6-2; Emission: EN 61000-6-3) RoHS Directive 2011/65/EU as last update by 2015/65/EU REACH Regulation (EC) n°1907/2006

6 HYDRAULIC CHARACTERISTICS

Valve model	RZGE-A-010		
Max regulated pressure	32; 100; 210		
Min. regulated pressure [bar]	0,8 (or actual value at T port)		
Max. pressure at port P [bar]	315		
Max. pressure at port T [bar]	210		
Max. flow [l/min]	12		
Response time 0-100% step signal (1) [ms] (depending on installation)	≤ 70		
Hysteresis [% of the max pressure]	≤ 1,5		
Linearity [% of the max pressure]	≤ 3		
Repeatability [% of the max pressure]	≤ 2		

Note: above performance data refer to valves coupled with Atos electronic drivers, see section [3](#)

(1) Average response time values; the pressure variation in consequence of a modification of the reference input signal to the valve is affected by the stiffness of the hydraulic circuit: greater is the stiffness of the circuit, faster is the dynamic response

7 ELECTRICAL CHARACTERISTICS

Power supplies	Nominal : +24 VDC Rectified and filtered : VRMS = 20 ÷ 32 VMAX (ripple max 10 % VPP)		
Max power consumption	30 W		
Coil voltage code	standard	option /6	option /18
Max. solenoid current	2,2 A	2,75 A	1 A
Coil resistance R at 20°C	3 ÷ 3,3 Ω	2 ÷ 2,2 Ω	13 ÷ 13,4 Ω
Insulation class	H (180°) Due to the occurring surface temperatures of the solenoid coils, the European standards ISO 13732-1 and EN982 must be taken into account		
Protection degree to DIN EN60529	IP65 with mating connectors		
Duty factor	Continuous rating (ED=100%)		
Certification	cURus North American Standard		

8 SEALS AND HYDRAULIC FLUIDS - for other fluids not included in below table, consult our technical office

Seals, recommended fluid temperature	NBR seals (standard) = -20°C ÷ +80°C, with HFC hydraulic fluids = -20°C ÷ +50°C FKM seals (/PE option) = -20°C ÷ +80°C HNBR seals (/BT option) = -40°C ÷ +60°C, with HFC hydraulic fluids = -40°C ÷ +50°C		
Recommended viscosity	20 ÷ 100 mm ² /s - max allowed range 15 ÷ 380 mm ² /s		
Max fluid contamination level	normal operation	ISO4406 class 18/16/13 NAS1638 class 7	see also filter section at
	longer life	ISO4406 class 16/14/11 NAS1638 class 5	www.atos.com or KTF catalog
Hydraulic fluid	Suitable seals type	Classification	Ref. Standard
Mineral oils	NBR, FKM, HNBR	HL, HLP, HLPD, HVLP, HVLPD	DIN 51524
Flame resistant without water	FKM	HFDU, HFDR	ISO 12922
Flame resistant with water	NBR, HNBR	HFC	

9 DIAGRAMS (based on mineral oil ISO VG 46 at 50 °C)

1 = Regulation diagrams
with flow rate Q = 1 l/min

Note: the presence of counter pressure at port T can affect the effective pressure regulation

2 = Pressure/flow diagrams
with reference signal set at Q = 1 l/min

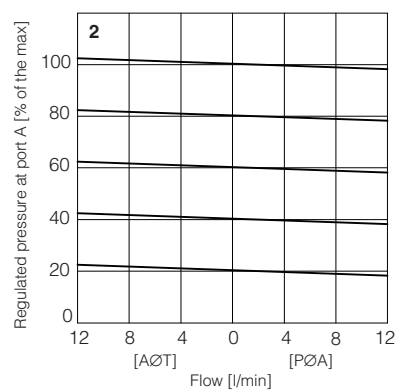
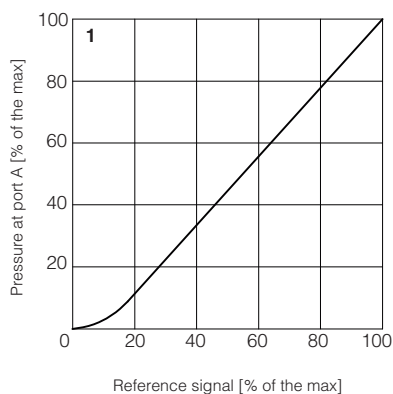

3-4 = Min. pressure/flow diagrams
with zero reference signal

3 = Pressure drops vs. flow P-A

4 = Pressure drops vs. flow A-T

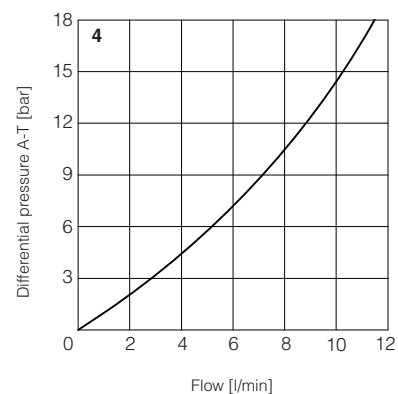
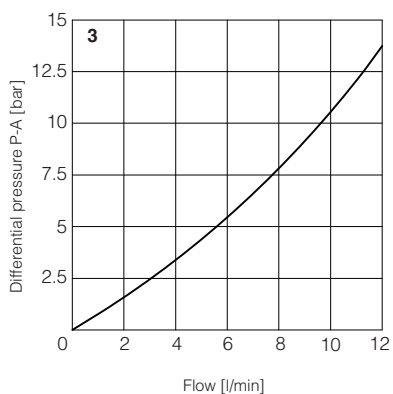

10 COIL VOLTAGE OPTIONS

6 = Optional coil to be used with Atos drivers with power supply 12 VDC.

18 = Optional coil to be used with electronic drivers not supplied by Atos, with power supply 24 VDC and with max current limited to 1A.

11 AIR BLEEDING

At the first valve commissioning the air eventually trapped inside the solenoid must be bled-off through the screw ① located at the rear side of the solenoid housing.
The presence of air may cause pressure instability and vibrations.

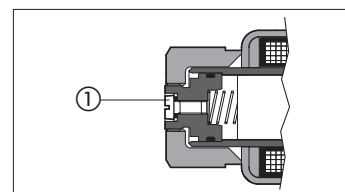

12 COILS WITH SPECIAL CONNECTORS

J option

Coil type COZEJ
AMP Junior Timer connector
Protection degree IP67

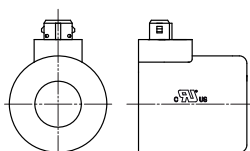

K option

Coil type COZEK
Deutsch connector, DT-04-2P male
Protection degree IP67

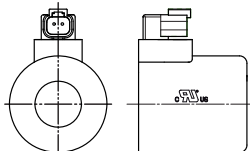

S option

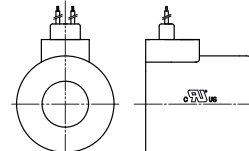

Coil type COZES
Lead Wire connection
Cable length = 180 mm

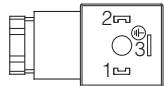

13 SOLENOID CONNECTION

PIN	SIGNAL	TECHNICAL SPECIFICATION	Connector code 666 
1	COIL	Power supply	
2	COIL	Power supply	
3	GND	Ground	

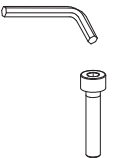
14 FASTENING BOLTS AND SEALS FOR RZGE

	<p>Fastening bolts: 4 socket head screws M5x50 class 12.9 Tightening torque = 8 Nm</p>
	<p>Seals: 3 OR 108 Diameter of ports P, T, A: \varnothing 5 mm Port B not used</p>

15 INSTALLATION DIMENSIONS FOR RZGE [mm]

ISO 4401: 2005
Mounting surface: 4401-03-02-0-05 (see table P005)
(without port B)

Mass [kg]	
RZGE	1,5
RZGE with E-MI-AS-IR	2,0

view from X

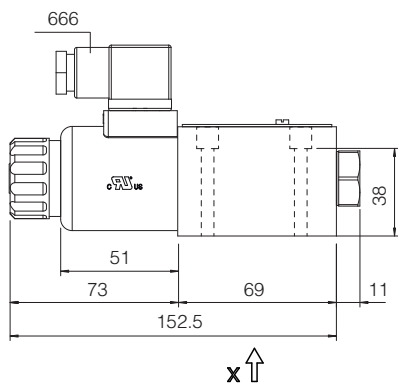
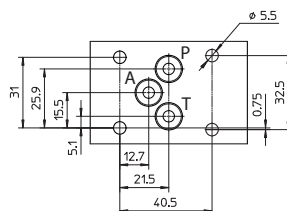

RZGE-A

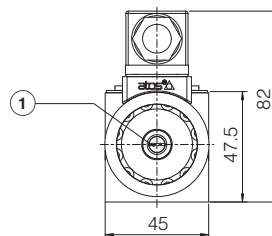

RZGE-A
(with E-MI-AS-IRdigital driver)

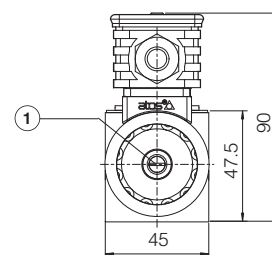
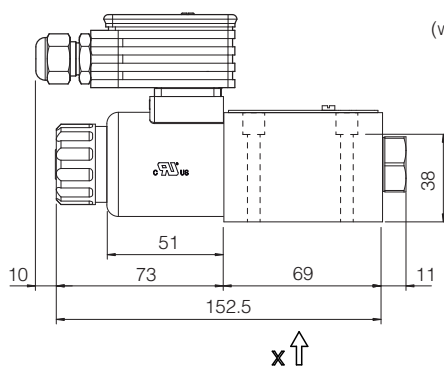

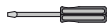
① = Air bleeding, see section 11 

16 INSTALLATION DIMENSIONS FOR CART RZGE [mm]

Cavity dimensions for **CART RZGE-A**

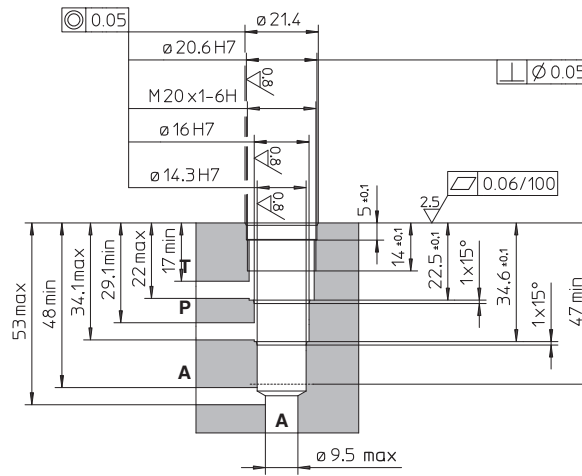

CART RZGE-A

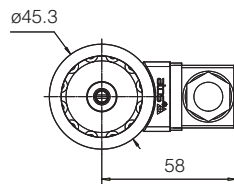
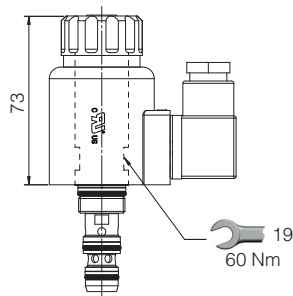

CART RZGE-A
(with E-MI-AS-IR digital driver)

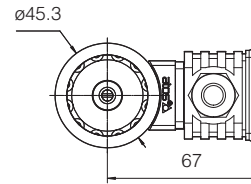
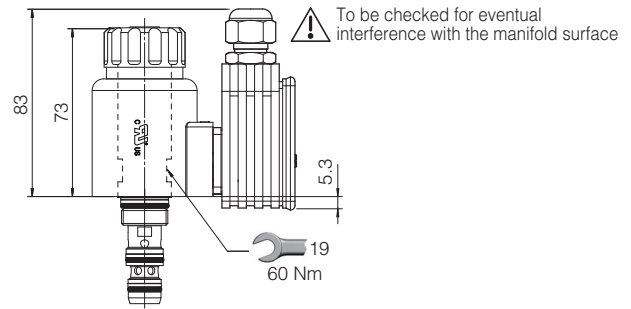

Mass [kg]

CART RZGE	0,6
CART RZGE with E-MI-AS-IR	1,1

17 RELATED DOCUMENTATION

FS001	Basics for digital electrohydraulics	GS050	E-BM-AES digital driver
FS900	Operating and maintenance information for proportional valves	GS500	Programming tools
G010	E-MI-AC analog driver	K800	Electric and electronic connectors
G020	E-MI-AS-IR digital driver	P005	Mounting surfaces for electrohydraulic valves
G030	E-BM-AS digital driver		